

MAINTENANCE/CUSTOMER ASSISTANCE

**Routine maintenance**

Every 10,000 miles/16,000 km or 12 months, whichever comes first\*

*\*Tip: Change your oil and filter more frequently (every 5,000 miles/8,000 km or every 6 months) if you drive under these conditions: High dust levels, low-speed short trips or extended idling, trailer towing, or extensive mountain driving*

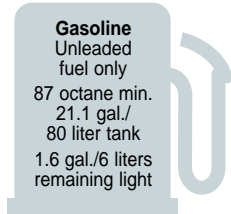

**VOLVO**

Drive Safely™

SP0332.07.95 22M  
© 1995 Calcar  
Quick Tips is a trademark of Calcar

**VOLVO CUSTOMER ASSISTANCE**

United States

**On Call  
Roadside Assistance  
800-63-VOLVO**

**Customer Support  
800-458-1552**

Canada

**On Call  
Roadside Assistance  
800-263-0475**

**Customer Support  
800-663-8255**

*Always check the Owner's Manual for more operating information and safety features*

QUICK TIPS™

1 9 9 6

VOLVO 960



## DASHBOARD/KEYS

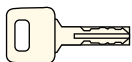

**Master key**  
Operates all locks, arms alarm from either front door or trunk/tailgate

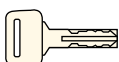

**Service (valet) key**  
Operates front doors, ignition/steering/transmission lock

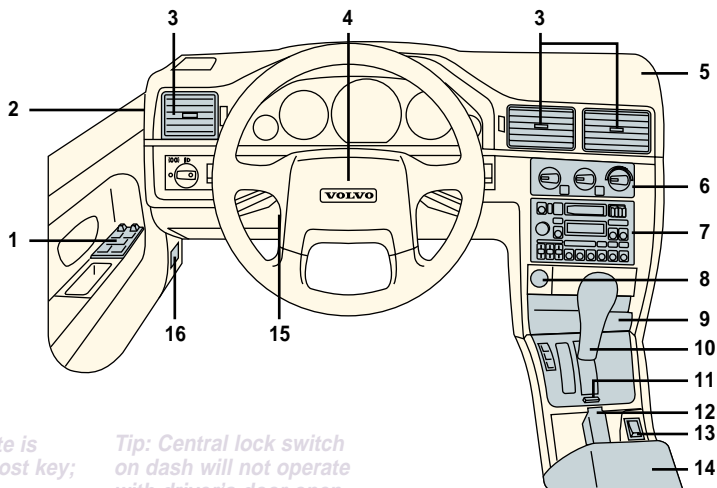

*Tip: Key number plate is used to purchase a lost key; store in safe place*

*Tip: Central lock switch on dash will not operate with driver's door open*

**1. Mirrors/power windows**  
See Driver Controls

**2. Fuse box**

**3. Air vents**

Open/closed: Rotate wheel down/up  
Horizontal air flow: Rotate center wheel left/right  
Vertical air flow: Push top/bottom of slats

**4. Horn**

**5. Red alarm LED (light on right speaker)**

Flashes when armed; alarm armed when door/tailgate locked, locks with key or remote; if activated, horn sounds and turn signals flash

**6. Heating & air conditioning**  
See Climate Controls

**7. Audio system**

See Audio System

**8. Cigarette lighter**

**9. Ash tray:** Push to open

**10. Gear selector**

See Drivetrain

**11. Shiftlock override button**

To override shiftlock system: Turn ignition *on*, press and hold override button, move gear selector out of Park (P)

**12. Parking brake**

**13. Heated front seats (if equipped)**

Press to turn on; automatically turns off when optimal temperature is reached

*Tip: Passenger seat heater should be off when seat is not occupied*

**14. Console**

See Trunk/Storage

**15. Tilt steering wheel**

Adjusts to three positions  
Push lever down to adjust, release to lock

*WARNING: Do not adjust steering wheel while driving*

**16. Hood release**

To open: Pull

*Always check the Owner's Manual for more operating information and safety features*

DASHBOARD/  
KEYS

**INSTRUMENT PANEL**

**INSTRUMENT PANEL**

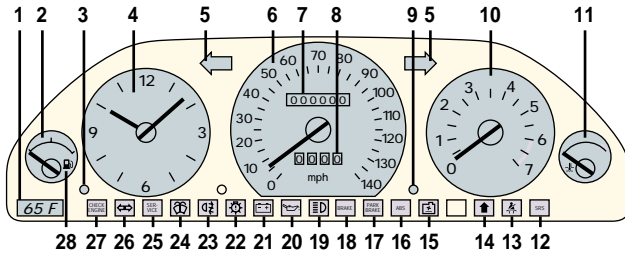

- 1. Outside temperature gauge**  
Amber lamp indicates near or below freezing conditions
- 2. Fuel gauge**  
Tank holds 21.1 gal./80 liters  
*Tip: If ignition on while refueling, gauge will not register additional fuel for up to 20 minutes*
- 14. Winter/wet transmission mode selected**  
Flashing indicates faulty transmission; also see Drivetrain
- 15. Low coolant level**
- 16. Anti-lock Brake System (ABS)**  
Malfunction, normal brakes only
- 17. Parking brake on**
- 18. Low brake fluid level**

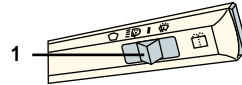

- Right stalk**
- Wiper/washer**  
Intermittent wipe: Press up  
Single wipe: Press down slightly  
Low speed = 1 click down  
High speed = 2 clicks down  
Wash (includes headlight wash if equipped): Pull
- 1. Rear wiper/washer (Wagon)**  
Intermittent wipe:  
Move center switch left  
Continuous wipe:  
Move switch right  
Wash: Push button on end of stalk

- 3. Clock set button**  
To set clock: Press while turning
  - 4. Clock**
  - 5. Turn signals**
  - 6. Speedometer**
  - 7. Odometer**
  - 8. Trip odometer**
  - 9. Trip odometer reset button**  
To reset to zero: Push
  - 10. Tachometer:** Avoid red zone
  - 11. Coolant temperature gauge**  
Stop car if in red zone, check coolant level when safe
- WARNING LIGHTS:**
- 12. Supplemental Restraint System (SRS)**  
Airbag malfunction
  - 13. Always fasten seat belts**
  - 19. High beams on**
  - 20. Low oil pressure**  
Check oil level
  - 21. Charging (generator) system failure:** Battery discharging
  - 22. Exterior light bulb failure**
  - 23. Rear fog lamp on**
  - 24. Low washer fluid**
  - 25. Scheduled maintenance reminder**  
Light on = service interval exceeded
  - 26. Trailer turn signal operating (if equipped)**
  - 27. Malfunction indicator lamp**  
Possible faulty emission control; Volvo retailer inspection required
  - 28. Low fuel warning light**  
Light comes on when 1.6 gal./6 liters fuel remaining

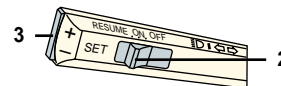

- Left stalk**
- Turn signals/high beams**  
Pull for high beams or to flash high beams with lights off
- Cruise control**  
*WARNING: Use only when safe*  
Operates above 22 mph  
To turn on: Set switch (2) to on  
To set speed: Press and release SET button (3) at end of lever  
To accelerate/decelerate: Press SET button (3) toward +/-  
To return to preset speed (after braking): Momentarily move switch (2) to RESUME  
To cancel: Tap brake pedal or push button (2) to off

*Always check the Owner's Manual for more operating information and safety features*

**STALKS**

DRIVER CONTROLS

DRIVER CONTROLS

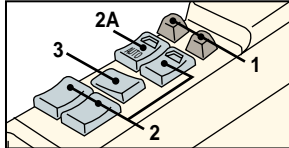

**1. Outside mirror controls**  
 Left/right switches adjust corresponding mirrors four ways  
 Push edge of adjustment switch to move mirror in corresponding direction

**2. Power windows**

Driver's window (2A): "One-touch" down; press bottom of switch lightly and release, window goes all the way down; tap switch again to stop; press and hold bottom of switch for normal operation

**3. Rear window cut-out switch**

Push left side to disable rear window controls; driver's switches retain control

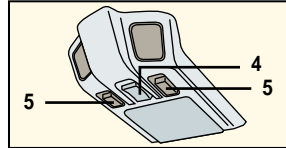

**Main interior light switch (4) and reading light switches (5)**

Always on: Forward position  
 Always off: Center position  
 On with open door: Rear position

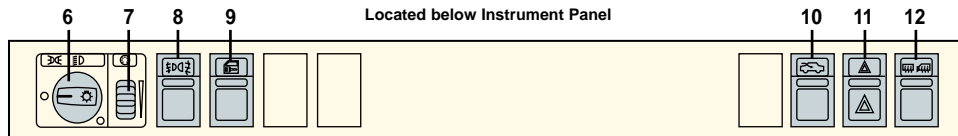

Located below Instrument Panel

**6. Headlights**

- All lights off; daytime running lights (DRL) on when ignition on
- Parking lights on; also controls DRL
- Headlights on when ignition on

*Tip: High beams can only be switched on if headlight switch is in position*

**7. Instrument panel illumination control**

To increase brightness: Rotate wheel up

**8. Fog lights**

Two front, one high-intensity red light in driver's-side rear lamp cluster  
 Operate only when headlights are on  
 Front fog lights on: Push top of switch  
 Front and rear fog lights on: Push bottom of switch  
 Fog lights off: Switch in center position

**9. Central locking**

To lock/unlock doors, trunk/tailgate: Push  
 Also see Locks

*Tip: Central lock switch on dash will not operate with driver's door open*

**10. Sunroof (if equipped)**

To slide open/closed: Press bottom/top of switch  
 To raise/close rear edge: Press top/bottom of switch

*Tip: To minimize wind rumble with sunroof open, open/close panel or rear window(s) slightly*

**11. 4-way hazard flashers**

**12. Heated rear window/side mirrors (if equipped)**

To turn on: Press switch  
 Mirrors off automatically after approximately six minutes, rear window after about 12 minutes

*Always check the Owner's Manual for more operating information and safety features*

DRIVER CONTROLS

LOCKS

LOCKS

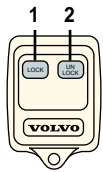

**Remote keyless entry**

Operates all locks from a distance

To operate: Hold remote in vertical position

To lock doors, trunk/tailgate: Press LOCK (1)  
To unlock: Press UNLOCK (2) to unlock driver's door; press again within 10 seconds to unlock other doors, trunk/tailgate

*Tip: Do not use keyless transmitter to lock an occupied vehicle*

*Tip: If only the driver's door is unlocked, lock will re-engage and alarm will reset in 30 seconds unless door is opened*

**Alarm**

Armed/deactivated via remote keyless entry or with key (red LED on right radio speaker flashes when armed); if activated, horn sounds and turn signals flash

*Tip: The alarm will be triggered if you attempt to open the car using the key in any lock except the one in the driver's door*

**Power door locks**

Key:

To lock all doors and trunk/tailgate: Use key in either front door

To unlock either front door: Turn key once

To unlock all doors and trunk/tailgate: Turn key, then turn again within 10 seconds

To lock/unlock car from inside: Use central lock switch; also see Driver Controls

*Tip: Central lock switch on dash will not operate with driver's door open*

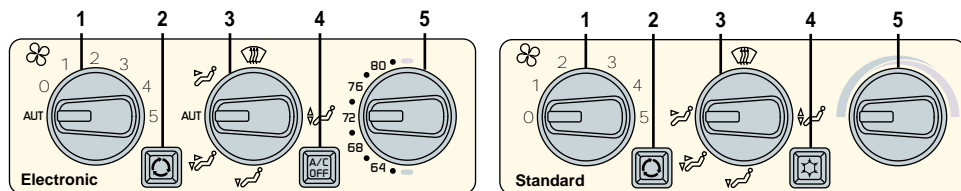

**1. Blower/fan for air circulation**  
AUT (if equipped) = blower is automatic; 0 = off; 5 = maximum

**2. Recirculate inside air**  
System on when button depressed (light on); push again for off

Recirculates air in passenger compartment for maximum heating or cooling  
Use when outside air becomes polluted; for 15-min. intervals max.

**3. Air vent selector:**

- Defrost: Air to windshield and side windows
- Air to floor, windshield and side windows
- Air to floor vents
- Air to floor and passenger panel vents
- AUT Air distribution is automatically regulated (if equipped)

Air to passenger panel vents

**4. Air conditioning**  
Standard system: Press to turn A/C on (light on)  
Electronic system: Press to turn A/C off (light on); use AUT settings for optimal cooling

**5. Temperature dial**  
*Tip (both systems): In defrost mode, A/C always on and recirculation always off*

*Always check the Owner's Manual for more operating information and safety features*

CLIMATE CONTROLS

SEATS

SEATS

- 1. Height adjustment**  
To raise or lower front/rear of seat: Push front/rear of switch vertically
- Fore-aft adjustment**  
To move seat fore and aft: Push horizontally
- 2. Seat back position**  
To tilt seat back: Push switch forward or rearward

**WARNINGS:**  
Do not place children in front  
Do not adjust seats while driving  
Seat belts should always be worn when vehicle is in motion  
Airbags are supplemental and do not replace seat belt usage

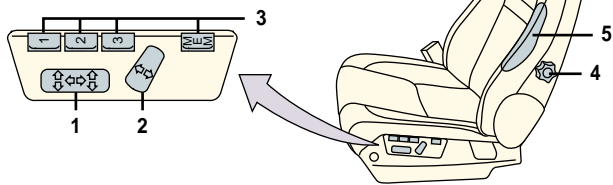

- 3. Programming seat memory**  
Adjust seat to desired position  
To retain in memory: Press and hold MEM and button 1, 2 or 3 simultaneously  
To bring seat to programmed memory: Press and hold 1, 2 or 3 until seat stops moving
- 4. Lumbar support**  
To increase/decrease lower back support: Turn knob
- 5. Side Impact Protection System (SIPS) airbag (front seats)**  
Helps increase occupant protection in certain side impact collisions  
*WARNING: Use only Volvo approved seat covers*

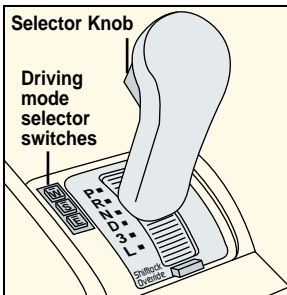

Gearshift must be in Park or Neutral to start engine; it must be in Park to remove ignition key

**P = Park**  
To move gearshift from Park: Press firmly on brake pedal, then press selector knob on gearshift  
*Never put moving vehicle in Park*

- R = Reverse**  
Never engage when vehicle is moving forward
- N = Neutral**  
No gear engaged; engine can be started in this position

**D = Drive**  
Normal driving position; shifts through four forward gears automatically when E or S modes selected

*Tip: Torque converter lock-up improves fuel economy and can feel like an additional gear change*

**3 = Drive, intermediate position**  
Shifts occur only through first three gears when modes E or S are selected; provides increased engine braking for moderate grades

**L = Drive, low position**  
Transmission remains in 1st or 2nd gear (no upshift when accelerating); provides engine braking when descending steep grades

**Driving mode selector switches**  
Control shifting of gears  
Press to activate/deactivate

**E = Economy**  
Use for normal driving, gear changes occur at lower engine speed to improve fuel economy

**S = Sport**  
Holds each gear to higher engine speed and downshifts faster

**W = Winter/wet**  
Use only when starting in extremely slippery conditions  
D = 3rd or 4th gear only  
3 = 2nd gear only  
L = 1st gear only

*Always check the Owner's Manual for more operating information and safety features*

DRIVETRAIN

**AUDIO SYSTEMS**

**RADIO/CASSETTE/CD**

- 1. Power/volume/balance (811)**  
To switch on and increase volume: Turn knob clockwise  
For balance: Pull and turn
- 2. Power (710/815)**  
To turn on/off: Push and hold
- 3. Volume/balance (710/815)**  
To change volume: Turn knob  
For balance: Pull and turn
- 4. Tuning (710/815)**  
Push left or right side of switch (811): Turn knob left/right  
Tape (815): Push for forward/ rewind  
CD (710/815): Push for music search
- 5. Bass/treble/fader controls**  
To increase/decrease: Slide up/down
- 6. AM/FM band selectors**
- 14. CD eject (815)**  
To stop and eject disc: Push
- 15. Prog (710)**  
To advance/rewind tape: Push ◀/▶  
To reverse tape direction: Push ◀◀ and ▶▶ simultaneously
- 16. Seek (710)**  
To automatically find next strong station/next CD selection: Push
- 17. Rnd (710/815)**  
For CD random play: Push
- 18. rew/ff (811)**  
To rewind/fast forward tape or CD: Push

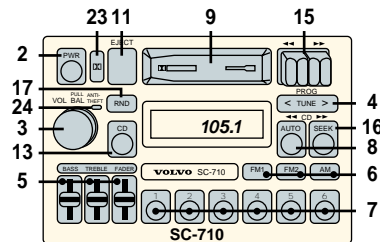
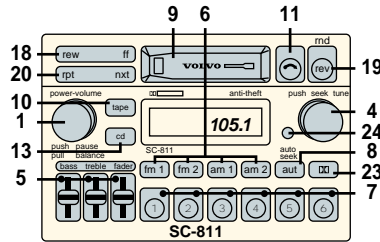

- 7. Preset buttons**  
To set station: Press and hold until sound fades and returns  
To select CD: Press 1-6
- 8. Aut/auto seek**  
To automatically seek and store eight strongest AM or FM stations: Press and hold for at least one second; press briefly to hear each station
- 9. Cassette slot**
- 10. Tape mode selector (811/815)**
- 11. Eject**  
To stop and eject tape: Push
- 12. CD slot (815)**  
Insert disc with label side up
- 13. CD mode selector (if equipped)**  
To activate CD: Press
- 19. rev/rnd (811)**  
To reverse tape direction/ CD random play: Push
- 20. Rpt/nxt (811); I◀/▶I (815)**  
To repeat or advance to next tape or CD selection: Push  
**(815 only)** To automatically seek next strong station: Push
- 21. Scan (815)**  
To listen to several seconds of each station or tape/CD selection: Push
- 22. Chgr (815)**  
To activate remote CD changer (if equipped): Push
- 23. DD Dolby® noise reduction**
- 24. Anti-theft indicator**

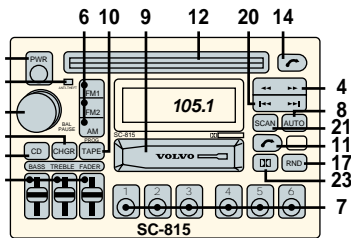

**Anti-theft feature**

If "codE" displayed, enter 4-digit code using preset buttons; EEEE displayed if incorrect code

*Tip: After three wrong attempts, radio locks for two hours*

*Tip: Clean cassette mechanism every 10-15 hours of use*

*Always check the Owner's Manual for more operating information and safety features*



**TRUNK/  
STORAGE**

**TRUNK/STORAGE**

**Trunk lid**

To open: Pull lever under lid

**Trunk light**

Located in trunk under rear window

Rotate switch forward = off

Rotate rearward = on (with lid open)

**Trunk/tailgate locking**

Locks/unlocks with either front door or central locking system

- ⊖ Trunk/tailgate locks/unlocks with central door locking; Withdraw key in vertical position
- ▶ Trunk/tailgate only is unlocked, relocks with doors; Turn key to right, then withdraw in vertical position
- ⊖ Trunk/tailgate always locked; Turn key to left, then withdraw in horizontal position

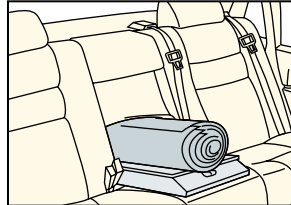

**Trunk pass-through (sedan)**

To stow long objects: Flip down rear center armrest; objects can be pushed from trunk through flap in seat; 33-lb maximum load

**Spare tire and jack**

Stowed under panel in trunk

*Tip: Always secure the spare tire and jack to prevent them from rattling*

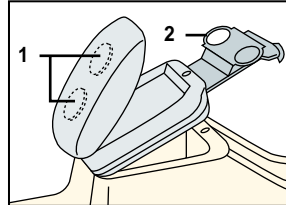

**Console (two-stage design)**

To open lid: Grip under front lip and pull up; lid flips 180° to serve as dual rear cupholders (1)

To access console storage: Pull up on latch at left front of console lid

Front cupholders (2): Grip under tab on front of console and pull forward

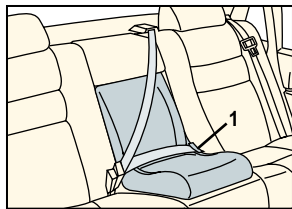

**Integrated child booster cushion (if equipped)**

*WARNING: Approved for children weighing between 50-80 lb and between 46-54 in. in height; not intended for children under three years of age*

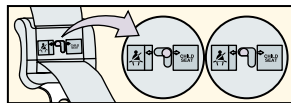

**Seat belt buckle locking mechanism**

Fitted to all belts except driver's; use when attaching seat belts to child restraint

To prevent seat belt from loosening around child restraint: Move red lock button to the right; belt retracts but won't extend

For normal belt extension/retraction adjustment: Move lock button left

*Tip: A coin, etc. can be used to move lock button*

*WARNING: Children should be placed only in rear seats*

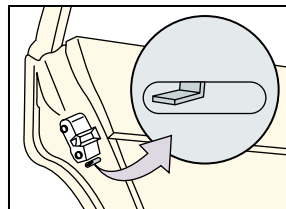

**Child safety locks**

Located at the edge of rear doors

To activate: Push lever toward center of car; door opens from outside only

*Always check the Owner's Manual for more operating information and safety features*

**CHILD SAFETY/  
REAR SEATS**



STATION WAGON

STATION WAGON

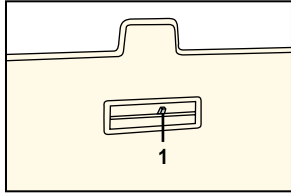

**Tailgate**

Locks/unlocks with either front door or central locking system (See Trunk/Storage)

To open from outside: Press up on catch on outside handle

To open from inside: Move handle (1) to left and push outward

*WARNING: Always close tailgate before driving; poisonous exhaust may enter vehicle*

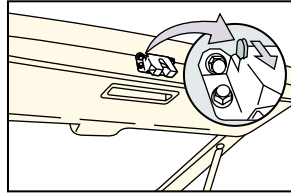

**Tailgate child safety lock**

Located on side of tailgate lock

To prevent tailgate from being opened from inside: Push lever down

**Cargo space lighting**

Located at rear of cargo area

Light on with tailgate open: Forward position

Light always off: Center position

Light always on: Rear position

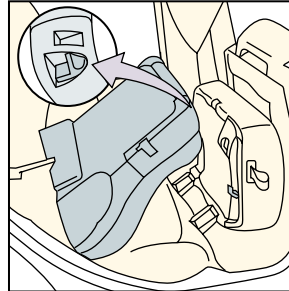

**Folding rear seats**

Rear seat is split into two sections and folds to expand cargo compartment

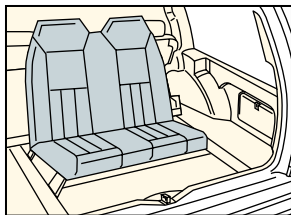

**Auxiliary child seat (if equipped)**

Rear-facing seat is intended for two children, each weighing a maximum of 84-lb and approximately 60 in. tall

*WARNING: Both rear seat backrests must be up when the auxiliary seat is being used*

*WARNING: Remove cargo net (if equipped) before using auxiliary child seat*

**Cargo net (if equipped)**

Helps prevent cargo/animals from being thrown forward

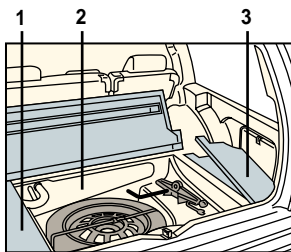

**Concealed storage bins**

Three bins (1, 2, 3) are located under cargo floor

**Spare tire and jack**

Located in large lockable storage bin (2)

**Luggage cover (if equipped)**

Pull out cover to conceal cargo

*Always check the Owner's Manual for more operating information and safety features*

STATION WAGON

**DRIVING TIPS/  
UNDER HOOD**

**DRIVING AND TIRE TIPS**

**Break-in (first 1,200 miles)**

Drive at varying road and engine speeds

Avoid full acceleration

Avoid transmission kick-down

**Engine warm-up**

Avoid prolonged idling; instead, drive with light pressure on accelerator for a few minutes

**Anti-lock Brake System (ABS)**

ABS automatically pumps the brakes to prevent wheel lock-up. You may feel a slight pulsing of the brake pedal and hear an audible modulation of the brakes,

this is normal when you have reached maximum braking for the road surface

*Tips: When braking, maintain constant pressure on the brake pedal*

*Do not pump the brakes*

**ABS Self Test**

A self-diagnostic test is performed when starting and up to 4 mph (6 km/h); you may notice some pulsation of the brake pedal and hear some noise

*Tip: The ABS self test is normal*

**Tire economy and tips**

Check pressures when tires are cold; pressure information can be found on label located on rear edge of front passenger door

**Snow tires**

Should be installed on all four wheels to increase traction

**Snow chains**

Install only on the rear wheels

Install chains as tightly as possible and re-tighten periodically

Tires should not be wider than 195 mm

**1. Battery**

**2. Main fuse box**

**3. Coolant expansion tank/  
Radiator**

Level should be between indicator marks; fill with 50/50 mixture Volvo anti-freeze and water

*WARNING: Never remove cap while engine is running or hot; remove only when cool*

**4. Engine oil filler cap**

Only use oil meeting API specification SG, SG/CD, SH or Energy Conserving (EC) II

**5. Power steering oil reservoir**

**6. Engine oil dipstick**

Level should be between indicator marks, avoid overfilling

**7. Brake fluid reservoir**

Fluid should be above MIN mark; check without removing cap

**8. Relay/fuse box**

**9. Air cleaner**

**10. Washer fluid reservoir**

Fill with mixture of water and solvent (use washer anti-freeze in winter)

**11. Hood safety latch**

To lift hood: Pull inside hood release handle, lift hood slightly and depress safety latch

*Tip: Transmission has no dipstick; your Volvo retailer can check if necessary*

*WARNING:  
Fan operates up to 6 minutes after engine has been shut off*

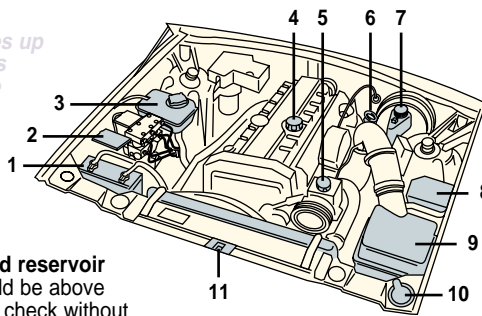

*Always check the Owner's Manual for more operating information and safety features*