



VOLVO
S60 R PRICING

VOLVO
for life



THE VOLVO S60 R

If you've been searching for a performance saloon car then look no further – the Volvo S60 R is one of the most advanced performance saloons available. Blessed with perfectly sculpted body work and a unique interior, it certainly looks the part. But it's under the surface where it really excels – take a look through this price list to find out about the S60 R's jaw dropping performance.

FOUR-C (CONTINUOUSLY CONTROLLED CHASSIS CONCEPT)

The S60 R is the world's first performance saloon without compromise thanks to its new Four-C chassis technology. Choose between three uniquely different driving modes that, at the touch of a button, radically alter the car's character. Comfort and Sport modes employ 'Skyhook' control technology to give either a flat comfortable ride or a firmer more sporting drive. Advanced Sport utilises 'Road Contact' control technology for an almost race car feel and ultimate speed.

300 BHP 5-CYLINDER TURBOCHARGED ENGINE

The new R turbocharged engine: 2.5 litres, 300 bhp, 0-62 mph in just 5.7 seconds (manual) and 400 Nm torque make it our most powerful engine yet. But what really impresses is the way that power is delivered. Four-C chassis technology with DSTC (Dynamic Stability and Traction Control) and the latest intelligent AWD optimise surface grip and traction to deliver that power where it matters most – the road. That means every ounce of power generated by the in-line 2.5 litre five-cylinder high pressure turbo-petrol engine contributes to the S60 R's surging performance. And yet the engine is equally characterised by its low emissions and refined behaviour – making it ideal for everyday driving.

UNIQUE R FEATURES

It's not often you meet a car that lives up to expectations – the S60 R however is an exception. Wherever you look, there's evidence of the car's pedigree – subtle styling changes like the aerodynamically redesigned front end, 'R' aluminium wheels and rear boot lid spoiler hint at the car's potential. Understated and elegant – the Volvo S60 R doesn't need to shout about its performance, to catch your attention. Step inside and the S60 R continues to impress: 'R' embossed three spoke steering wheel, blue chronograph-inspired instruments, sports seats in a choice of three exclusive leather finishes and the most important detail of all – three chassis mode buttons on the dash.

CHOOSE YOUR VOLVO	2-3
STANDARD AND OPTIONAL EQUIPMENT	4-5
ACCESSORIES & UPHOLSTERY	6-7
TECHNICAL SPECIFICATION	8-9
CHOOSE YOUR COLOUR	10
CARE BY VOLVO	11

S60 R

The unique specification of the S60 R includes electronic climate control, blue chronograph R instrument dials, Bi-Xenon Headlamps, 17" or 18" Pegasus alloy wheels, 4 x CD player and 9 Speakers, DSTC (Dynamic Stability and Traction Control), R Sports seats with metallic soft leather upholstery, plus all the safety features you would expect from Volvo.

	Basic £	VAT £	Rec Retail Price £	On The Road Price £	On The Road Price € Euros ⁽ⁱ⁾
PETROL					
S60 R (6 Speed Manual)	£28,497.87	£4,987.13	£33,485.00	£34,150.00	€52,522.70
S60 R (5 Speed Geartronic)	£29,561.70	£5,173.30	£34,735.00	£35,400.00	€54,445.20



(i) Euro prices shown are for information only and are calculated using an exchange rate of 1.538 Euros to the £, as published in the Financial Times on 6th January 2003. Euro prices will be subject to the prevailing exchange rate at the time of purchase. These figures are for information purposes only.

	S60 R
SAFETY & SECURITY	
Dual Stage Driver and Passenger Airbags	•
SIPS (Side Impact Protection System)	•
SIPS Airbags	•
IC (Inflatable Curtain)	•
WHIPS (Whiplash Protection System) (Front Seats)	•
ABS (Anti-lock Brakes) with EBD (Electronic Brake Distribution)	•
Aluminium 4 Piston Brembo Brake Callipers with R Logo	•
DSTC (Dynamic Stability and Traction Control) with Electronic Brake Assistance	•
Speed Dependent Steering System	•
5 Three Point Seat Belts	•
Seat Belt Pre-tensioners (Front and Rear)	•
Head Restraints – All 5 Seats	•
ISOFIX Child Seat Preparation	•
Anti-theft Alarm including Immobiliser and Panic Function	•
Key Integrated Remote Control (R Logo) Central Locking including Fuel Flap with Deadlocking System	•
Mass Movement Sensor	•
Day Running Lights	•
Headlamp Levelling System	•
High Level LED Brake Light	•
Side Marker Bumper Illumination	•
Home Safe and Approach Lighting	•
INTERIOR	
ECC (Electronic Climate Control) with AQS (Air Quality System) and Pollen Filter	•
B Pillar Ventilation	•
Exterior Temperature Gauge	•
Information Centre	•
Cruise Control	•
Front and Rear Electric Windows	•
Electrically Adjustable and Heated Door Mirrors	•
Electric Folding Door Mirrors with Ground Lights	•
Electric Folding Rear Headrests	•
Illuminated Driver and Passenger Vanity Mirrors	•
Front and Rear Reading Lamps	•
Autodimming Rear View Mirror	•
Cupholder in Dashboard ⁽ⁱⁱ⁾ , Two Cupholders in Tunnel Console	•
Grocery Bag Holder	•
12v Socket (Rear of Tunnel Console)	•
Rear Waste Bag/Bottle Holder	•
Electric Driver's Seat (with Memory) and Door Mirror Memory	•
Height Adjustable Passenger Seat	•
Forward Folding Front Passenger Seat	•
Asymmetric Split-folding Rear Seat	•
Heated Front Seats	•
Front Centre Armrest	•
R Leather Steering Wheel, Instrument Binnacle, Door Grab Handles, Gear Knob and Handbrake Lever with Blue Stitching	•
Steering Wheel Remote Audio Controls	•
Height and Reach Adjustable Steering Column	•
Illuminated Ignition Lock	•
Space Ball Gear Knob – Manual only	•
Blue/Silver Chronograph Instrument Dials	•
Brushed Aluminium Trim	•
R Sports Seats with Metallic Soft Leather Upholstery	•
HU-803 RDS 4 x CD Radio with Dolby Pro Logic Surround Sound ^{TM(iii)} with 4 x 50W Amplifier and 9 Speakers	•
Electronic Accessory Preparation	•
Luxury Colour Co-ordinated Floor Mats	•
EXTERIOR	
17" Pegasus Alloy Wheels – 235/45Y Pirelli P-Zero Rosso Tyres	•
Locking Wheel Nuts	•
Tempa Spare Wheel	•
Projector Type Front Fog Lights	•
Bi-Xenon Headlamps (Matt Silver Bezel) with Headlamp Wash/Wipe	•
Rear Spoiler	•
Rain Sensor – Automatic Windscreen Wiper Activation	•
Active Four-C (Continuously Controlled Chassis Concept)	•
Electronic All Wheel Drive System (Haldex Coupling)	•
Towbar Preparation	•
Stainless Steel Door Sills with R Logo	•
Unique Black Grille with Matt Silver Surround and R Logo	•
Unique Front Design – Fully Integrated Spoiler, Large Lower Air Intake, Split Front Rubbing Strip	•
Twin Tailpipes and Surround	•



	Basic £	VAT £	Rec Retail Price £	Rec Retail Price € ⁽ⁱ⁾	S60 R
SAFETY & SECURITY					
Delete Passenger Airbag	–	–	–	–	nco
Laminated Side Windows	£255.32	£44.68	£300.00	€461.40	o
Inclination Sensor	£106.38	£18.62	£125.00	€192.25	o
Power Child Locks (Rear Doors)	£63.83	£11.17	£75.00	€115.35	o
Integrated Child Seat (Rear Centre Armrest) ^(iv)	£110.64	£19.36	£130.00	€199.94	o
INTERIOR					
Geartronic Transmission (5 speed)	£1,063.83	£186.17	£1,250.00	€1,922.50	o
Electric Glass Tilt & Slide Sunroof	£595.74	£104.26	£700.00	€1,076.60	o
Sun Curtain (Rear Shelf – Manual)	£85.11	£14.89	£100.00	€153.80	o
Ashtray and Cigarette Lighter	–	–	–	–	nco
Rear Cupholders (Armrest)	£29.79	£5.21	£35.00	€53.83	o
First Aid Kit	£17.02	£2.98	£20.00	€30.76	o
Electric Driver and Passenger Seats (with Driver's Memory) and Door Mirror Memory	£510.64	£89.36	£600.00	€922.80	o
Atacama Natural Leather Upholstery	£1,080.85	£189.15	£1,270.00	€1,953.26	o
HU-803 RDS Audio Max 4 x CD Radio with Dolby Pro Logic Surround Sound ^{TM(iii)} , 4 x 75W Amplifier and 13 Speakers	£212.77	£37.23	£250.00	€384.50	o
RTI Navigation System, Remote Control with Europe DVD Map without TV	£1,872.34	£327.66	£2,200.00	€3,383.60	o
RTI Navigation System, Remote Control with Europe DVD Map and TV	£2,297.87	£402.13	£2,700.00	€4,152.60	o
Dual Band Integrated GSM Telephone ⁽ⁱⁱⁱ⁾	£595.74	£104.26	£700.00	€1,076.60	o
Handsfree Phone System ⁽ⁱⁱ⁾			Available Q4 2003		o
Handsfree Phone System (inc. Audio Mute Function) ⁽ⁱⁱ⁾			Available Q4 2003		o
EXTERIOR					
Metallic/Pearlescent Paint	£425.53	£74.47	£500.00	€769.00	o
18" Pegasus Alloy Wheels – 235/40Y Pirelli P-Zero Rosso Tyres	–	–	–	–	nco
18" Pegasus Alloy Wheels (Graphite) – 235/40Y Pirelli P-Zero Rosso Tyres	–	–	–	–	nco
Towbar – Detachable Type with 7 Pin Electrics ⁽ⁱⁱ⁾	£350.29	£61.30	£411.59	€633.03	o
Towbar – Detachable Type with 13 Pin Electrics ⁽ⁱⁱ⁾	£404.70	£70.82	£475.52	€731.35	o
Park Assist, Rear ⁽ⁱⁱ⁾	£329.64	£57.69	£387.33	€595.71	o
Park Assist, Rear with Audio Mute ⁽ⁱⁱ⁾	£370.21	£64.79	£435.00	€669.03	o



17" Pegasus



18" Pegasus



18" Pegasus (Graphite)

	Basic £	VAT £	Rec Retail Price £	Rec Retail Price € ⁽ⁱ⁾	S60 R
FAMILY PACK^(v)					
Integrated Child Seat (Rear Centre Armrest), Power Child Locks and Sun Curtain (Rear, Shelf, Manual)	£187.23	£32.77	£220.00	€338.36	o
COMMUNICATIONS PACK 1					
Dual Band Integrated GSM Telephone ⁽ⁱⁱⁱ⁾ , RTI Navigation System, Remote Control with Europe DVD Map	£1,957.45	£342.55	£2,300.00	€3,537.40	o
COMMUNICATIONS PACK 2					
Dual Band Integrated GSM Telephone ⁽ⁱⁱⁱ⁾ , RTI Navigation System, Remote Control with Europe DVD Map and TV.	£2,297.87	£402.13	£2,700.00	€4,152.60	o

o = optional

n/a = not available

nco = no cost option i.e. a customer can upgrade to that option without paying any extra money.

u = upgrade i.e. a customer can upgrade to that option but will pay the difference in price, upgrade price shown in (£).

(i) Euro prices shown are for information only and are calculated using an exchange rate of 1.538 Euros to the £, as published in the Financial Times on 6th January 2003.

Euro prices will be subject to the prevailing exchange rate at the time of purchase. These figures are for information purposes only.

(ii) Indicates total fitted price. At participating dealers only. To find out who is a participating dealer contact the Volvo Helpline number on 0800 400 430.

(iii) Cupholder in Dashboard is removed when Dual Band Integrated GSM Telephone is ordered.

(iv) Dolby and Pro Logic Surround SoundTM are trademarks of Dolby Laboratories Licensing Corporation.

(v) Cannot be ordered in conjunction with Atacama Natural Leather Upholstery.

ACCESSORIES	Basic £	VAT £	Rec Retail Price £	Rec Retail Price € ⁽ⁱ⁾
EXTERIOR ACCESSORIES (PRICES EXCLUDE FITTING UNLESS SHOWN OTHERWISE)				
Bike Rack (down tube clamp)	£51.06	£8.94	£60.00	€92.27
Bike Rack (servo lift)	£80.85	£14.15	£95.00	€146.11
Bumper Protector	£42.55	£7.45	£50.00	€76.89
Load Basket	£85.11	£14.89	£100.00	€153.81
Load Carrier	£68.09	£11.92	£80.00	€123.05
Roofbox – Sport Time 50 (310 litre volume)	£187.23	£32.77	£220.00	€338.35
Roofbox – Weekender (370 litre volume)	£212.77	£37.23	£250.00	€384.51
Roofbox – Dynamic 65 (405 litre volume)	£229.79	£40.21	£270.00	€415.26
Roofbox – Sport Time 20 (450 litre volume)	£263.83	£46.17	£310.00	€476.78
Roofbox – Dynamic 85 (510 litre volume)	£297.87	£52.13	£350.00	€538.30
Ski/Snowboard Carrier with Slide Rail	£59.58	£10.42	£70.00	€107.66
INTERIOR				
Boot Mat – rubber	£72.34	£12.66	£85.00	€130.73
Boot Mat – textile/rubber reversible	£76.60	£13.40	£90.00	€138.43
Cooler/Hot Box (excludes price for power cable)	£68.09	£11.92	£80.00	€123.05
Fire Extinguisher (excludes installation kit)	£21.28	£3.72	£25.00	€38.76
First Aid Kit	£17.02	£2.98	£20.00	€30.76
Load Securing Straps (cargo area)	£17.02	£2.98	£20.00	€30.76
Load Securing Net (cargo area)	£59.58	£10.43	£70.00	€107.66
Net Pocket (cargo area)	£25.53	£4.47	£30.00	€46.14
Padded Neck Cushion	£17.02	£2.98	£20.00	€30.76
PC table for laptop computers	£59.58	£10.43	£70.00	€107.67
Rubber Floor Mats (set of four)	£63.83	£11.17	£75.00	€115.35
Sunblind – rear window	£51.06	£8.94	£60.00	€92.27
Sunblind – rear door windows (pair)	£51.06	£8.94	£60.00	€92.27
Table – rear centre arm rest	£17.02	£2.98	£20.00	€30.76
CHILD ACCESSORIES				
Child Booster Cushion	£29.79	£5.21	£35.00	€53.83
Child Booster Backrest (to go with above)	£29.79	£5.21	£35.00	€53.83
Padded Upholstery – for booster seat and headrest	£51.06	£8.94	£60.00	€92.27

(i) Euro prices shown are for information only and are calculated using an exchange rate of 1.538 Euros to the £ as published in the Financial Times on 6th January 2003.
Euro prices will be subject to the prevailing exchange rate at the time of purchase. These figures are for information purposes only.
(ii) Denotes the colour of the door panels above the Inlay Trim.

For further information and a complete list of all Volvo Accessories, just take a look at the new Accessory website at www.volvocars.co.uk/accessories.

UPHOLSTERY	Upholstery Code	Upholstery Colour	Dashboard Top/ Door Panel Colour ⁽ⁱⁱ⁾	Door Insert Colour	Headliner Colour
Gobi Soft Leather	9577	Beige/Gold Metallic	Charcoal	Beige/Gold Metallic	Granite
Nordkap Soft Leather	9576	Blue/Silver Metallic	Charcoal	Blue/Silver Metallic	Granite
Atacama Natural Leather	9675	Natural Leather	Charcoal	Natural Leather	Granite

UPHOLSTERY

S60 R

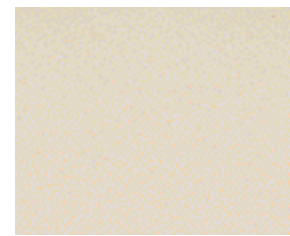

Gobi Soft Leather (9577)



Nordkap Soft Leather (9576)



Atacama Natural Leather (9675)

INTERIOR INLAY



Brushed Aluminium



NB It is not possible to reproduce exact original shades in printed matter.

ENGINE	Manual	Geartronic
Configuration	Transverse - 20 valve	Transverse – 20 valve
Cylinders	5	5
Engine capacity, cc	2521	2521
Bore x stroke, mm	83 x 93	83 x 93
Max. output ECE, bhp/kw/rpm	300/220/5500	300/220/6000
Max. torque ECE, Nm/rpm	400/1950-5250	350/1850-6000 Auto
Octane rating	95-98 RON ⁽ⁱ⁾ unleaded	95-98 RON ⁽ⁱ⁾ unleaded
Fuel system	Multipoint fuel injection	Multipoint fuel injection
Compression ratio	8.5:1	8.5:1

INSURANCE GROUPS	
Volvo S60 R	18

WEIGHTS	
Min. kerb weight, kg (actual kerb weight dependent on spec)	1637
Max. possible towing weight braked, kg	1600
Max. towing weight unbraked approx, kg ^(iv)	750
Max. total weight, kg	2110
Max. roof load, kg	100
Max. payload, kg (dependent on spec)	473

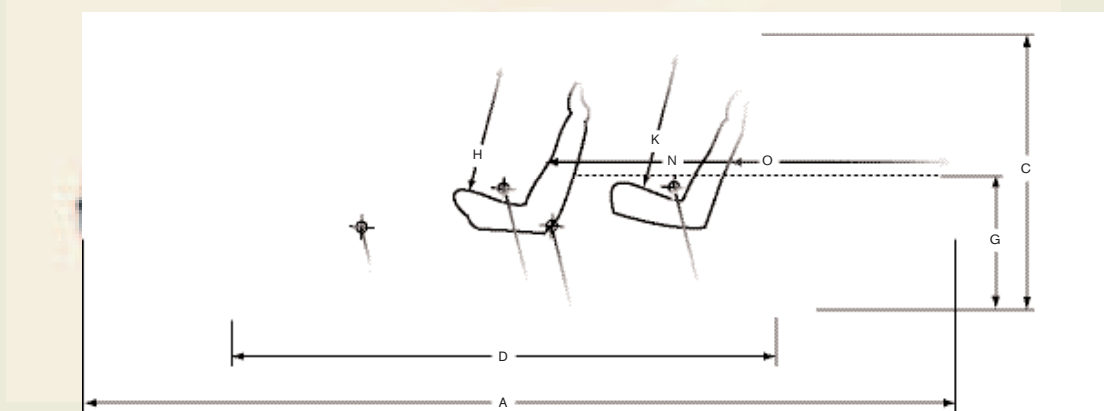

EXTERIOR (mm)		INTERIOR (mm)	
A Overall length	4606	H Front seat max. headroom ^(v)	984
B Overall width (exc. wing mirrors)	1804	I Front seats width	1427
C Unladen height	1431	J Front seat max. legroom	1082
D Wheelbase length	2715	K Rear seat max. headroom ^(v)	962
E Front track width	1557	L Rear seats width	1409
F Rear track width	1542	M Rear seat max. legroom	847
G Rear Load Height	661	N Load length luggage 2 seat mode	1727
		O Load length luggage 5 seat mode	1047

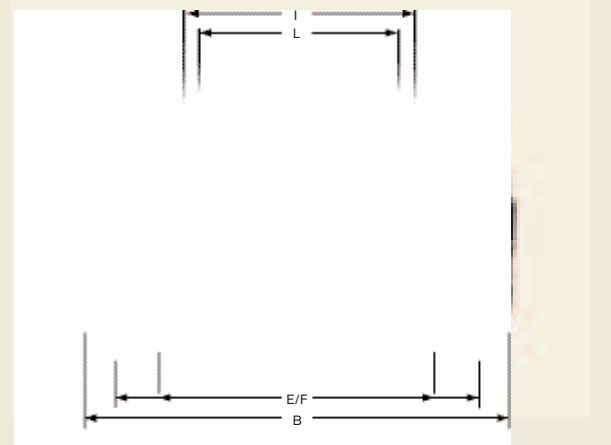

PERFORMANCE	Manual	Geartronic
Top speed, mph	155	155
Acceleration 0-62 mph, sec	5.7	7.5
Drag co-efficient	0.29	0.29

FUEL CONSUMPTION ⁽ⁱⁱ⁾	Manual	Geartronic
(Government Approved) Mpg (l/100 km) ⁽ⁱⁱⁱ⁾		
Urban	19.2 (14.7)	17.5 (16.1)
Extra Urban	34.0 (8.3)	34.4 (8.2)
Combined	26.4 (10.7)	25.4 (11.1)
CO ₂ g/km	256	266
VED (Vehicle Excise Duty) Band	D	D
Fuel tank volume, litres (gallons)	68 (15.0)	68 (15.0)

TRANSMISSION	
Manual	6 speed
Geartronic	5 speed

POWER STEERING SYSTEM	
(rack & pinion)	
Turning Circle, m (ft)	13.0 (42.7)

BRAKES	
Disc diameter mm, front	330
Disc diameter mm, rear	330

LUGGAGE COMPARTMENT	
Volume, litres (cu. ft)	394
Volume, rear seats down, litres (cu. ft)	808

TYRES	
17" Pegasus Alloy Wheels – 235/45Y Pirelli P-Zero Rosso	
18" Pegasus Alloy Wheels – 235/40Y Pirelli P-Zero Rosso	
18" Pegasus Alloy Wheels (Graphite) – 235/40Y Pirelli P-Zero Rosso	

- (i) For best performance and lowest fuel consumption 98 RON is recommended. 95 RON can be used for normal driving.
- (ii) These results do not express or imply any guarantee of the fuel consumption of a particular car as there are inevitable differences between individual cars of the same model. Additionally driving style, traffic conditions, as well as the age and mileage and standard of maintenance will affect a car's fuel consumption.
- (iii) The Urban fuel consumption figure is based on typical city driving, including starting the car from cold. The Extra Urban figure is based on typical motorway driving and cruising. The Combined figure averages the consumption across both cycles.
- (iv) Unbraked towing weight must not exceed 50% of kerb weight up to a maximum of 750 kg.
- (v) Figure quoted without sunroof.

Notes

Some specifications may have lower CO₂ emissions than those shown. Once a vehicle has been built it will be given its own specific CO₂ emission figure on which Vehicle Excise Duty and company car tax, where appropriate, will be calculated. Please contact your dealer for details.

A weighbridge must be used to determine specific weights.

Data valid for manual transmission unless specified.

All measurements in mm.

Some of the information in this price list may not be correct due to product changes which may have occurred since it was printed. Some of the equipment described or shown may now be available at extra cost. Before ordering, please ask your Volvo dealer for the latest information. The manufacturer reserves the right to make changes at any time, without notice, to price, colour, materials, specifications and models.

Volvo Car UK Limited, Globe Park, Marlow, Buckinghamshire, SL7 1YQ.



426
Silver metallic

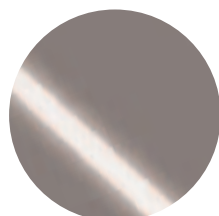

455
Titanium Grey pearl

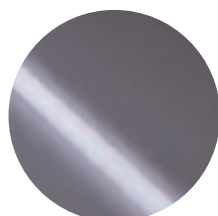

450
Cosmos Blue metallic

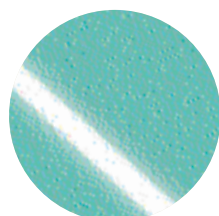

457
Flash Green pearl

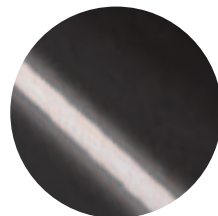

452
Black Sapphire metallic

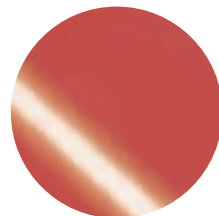

612
Passion Red



Care by Volvo is a range of tailored benefits, facilities and services to make sure you get the maximum enjoyment from your Volvo.

FINANCE



We make finance simple, clear and attractive. For private motorists, our flexible purchase schemes like Volvo Advantage make ownership affordable, with low monthly payments and low minimum deposit⁽ⁱ⁾. For business users, Volvo purchase plans, leasing and contract hire facilities offer tax efficient, versatile finance alternatives.

ASSISTANCE



Every new car comes with one year's free RAC cover. You'll enjoy full breakdown and recovery assistance, anywhere in Europe, 24 hours a day. You can even extend cover for up to two more years at preferential rates.

OWNERS INSURANCE



Statistics show Volvo drivers have fewer accidents. That means Volvo Owners insurance can offer competitive premiums with tailored protection and exclusive benefits. Operated in conjunction with The Royal and SunAlliance, one telephone call even deals with all arrangements for any claim.

WARRANTY



Every new Volvo comes with comprehensive protection. Our warranty covers the first three years or 60,000 miles, whichever comes first. There's a three year unlimited warranty on the paintwork, and a full 8 years against rust perforation. If a component fails due to a defect or material fault, your dealer will swiftly rectify the problem, free of charge.

All 'On The Road' prices quoted in this price list include Volvo standard national delivery charge, inclusive of number plates, at £480 and the VED (Vehicle Excise Duty) car tax effective from 1st March 2000. The 'On The Road' price also includes a £25 vehicle first registration fee (as set by the government), effective since 1st April 1998 (excludes Channel Islands and Isle of Man). Retail prices quoted do not include these additions.

Details

The above is just an outline of the facilities available to Volvo Owners. For full details, contact your dealer, or visit www.volvocars.co.uk

⁽ⁱ⁾ Subject to status. Written quotations are available from Volvo Car Finance Limited, Globe Park, Marlow, Buckinghamshire SL7 1YQ.

