



VOLVO
C70 PRICING

VOLVO
for life



THE VOLVO C70

The rare combination of performance, precision and stability makes it easy to enjoy life behind the wheel of a Volvo C70 Convertible. The sense of freedom and exhilaration is never further away than the touch of a button combining the performance of three engines ranging between 163 bhp and 245 bhp and three generous specification levels. Unique safety solutions like our protection systems for side collisions, rear collisions and roll-over accidents make the Volvo C70 Convertible one of the world's safest open cars.

T5

The T5 2.3 litre, turbocharged, in-line, 5 cylinder engine delivers outstanding performance – producing 245 bhp and 330 Nm torque. This extremely smooth engine features variable valve timing on the exhaust side and a responsive turbocharger designed to deliver maximum torque from low and medium engine speeds. Effortless performance and refinement are balanced with excellent fuel consumption.

DOLBY SURROUND PRO LOGIC

The Volvo C70 was the first car in the world to be available with the Dolby Pro Logic Surround System™⁽ⁱⁱ⁾. The Pro Logic option adds an audio processor and a centre loudspeaker to the existing high performance sound system and delivers a 'wrap around' sound which transforms the car into a concert hall.

CHOOSE YOUR VOLVO	2-3
STANDARD EQUIPMENT	4
OPTIONS	5
ACCESSORIES & UPHOLSTERY	6-7
TECHNICAL SPECIFICATION	8-9
CHOOSE YOUR COLOUR	10
CARE BY VOLVO	11

C70

The comprehensive standard specification includes full electric soft top, glass rear screen, wind deflector, electronic climate control, full leather faced upholstery, 16" Zeus alloy wheels, cruise control and a 10-speaker CD player – not forgetting ROPS (Roll-Over Protection System), ABS, EBD and a full complement of front and side airbags.

PETROL	Basic £	VAT £	Rec Retail Price £	On The Road Price £	On The Road Price € ⁽ⁱ⁾ Euros
C70 2.0T	£20,595.74	£3,604.26	£24,200.00	£24,878.00	€37,217.49

C70 COLLECTION

The C70 Collection Special Edition is sumptuously equipped with a choice of Toscana Tan or Black soft leather upholstery with heated seats. With a choice of 3 metallic paint colours as standard and unique 17" Otrera alloy wheels, this distinctive C70 delivers on style.

PETROL	Basic £	VAT £	Rec Retail Price £	On The Road Price £	On The Road Price € ⁽ⁱ⁾ Euros
C70 2.0T Collection	£22,042.55	£3,857.45	£25,900.00	£26,578.00	€39,760.69
C70 2.4T Collection	£23,489.36	£4,110.64	£27,600.00	£28,278.00	€42,303.89
C70 T5 Collection	£24,936.17	£4,363.83	£29,300.00	£29,978.00	€44,847.09

C70 GT

The GT models offer enhanced specification including a comprehensive information centre, heated front seats, 3 x CD player with Dolby Pro Logic Surround System™⁽ⁱⁱ⁾ and 17" Cratos alloy wheels which you can add to the already extensive specification.

PETROL	Basic £	VAT £	Rec Retail Price £	On The Road Price £	On The Road Price € ⁽ⁱ⁾ Euros
C70 2.0T GT	£22,042.55	£3,857.45	£25,900.00	£26,578.00	€39,760.69
C70 2.4T GT	£23,489.36	£4,110.64	£27,600.00	£28,278.00	€42,303.89
C70 T5 GT	£24,936.17	£4,363.83	£29,300.00	£29,978.00	€44,847.89



(i) Euro prices shown are for information only and are calculated using an exchange rate of 1.496 Euros to the £, as published in the Financial Times on 31st March 2004. Euro prices will be subject to the prevailing exchange rate at the time of purchase. These figures are for information purposes only.

(ii) Dolby and Pro Logic Surround Sound™ are trademarks of the Dolby Laboratories Licensing Corporation.

SAFETY & SECURITY	C70	COLLECTION	C70 GT
Driver and Passenger Airbags	•	•	•
SIPS (Side Impact Protection System)	•	•	•
SIPS Airbags	•	•	•
ROPS (Roll Over Protection System)	•	•	•
WHIPS (Whiplash Protection System) (Front Seats)	•	•	•
ABS (Anti-lock Brakes) with EBD (Electronic Brake Distribution)	•	•	•
STC (Stability and Traction Control)	•	•	•
4 Three Point Seat Belts	•	•	•
Seat Belt Pre-tensioners (Front)	•	•	•
Head Restraints – All 4 Seats	•	•	•
Anti-theft Alarm and Immobiliser	•	•	•
Remote Control Central Locking including Fuel Flap with Deadlocking System	•	•	•
Mass Movement Sensor	•	•	•
Tinted Windows	•	•	•
Visible VIN Plate	•	•	•
Day Running Lights	•	•	•
Headlamp Levelling System	•	•	•
High Level LED Brake Light	•	•	•
Home Safe Lighting	•	•	•
INTERIOR	C70	COLLECTION	C70 GT
ECC (Electronic Climate Control) and Pollen Filter	•	•	•
Exterior Temperature Gauge	•	•	•
Information Centre	•	•	•
Cruise Control	•	•	•
Front and Rear Electric Windows	•	•	•
Electrically Adjustable and Heated Door Mirrors	•	•	•
Illuminated Driver and Passenger Vanity Mirrors	•	•	•
Front and Rear Reading Lamps	•	•	•
Autodimming Rear View Mirror	•	•	•
Front Cupholders	•	•	•
Height Adjustable Driver and Passenger Seats	•	•	•
Driver and Passenger Seat Mechanism for Access to Rear	•	•	•
Heated Front Seats	•	•	•
Front Centre Armrest	•	•	•
Leather Steering Wheel	•	•	•
Leather Sports Steering Wheel	•	•	•
Leather Handbrake Lever and Gear Knob	•	•	•
Height and Reach Adjustable Steering Column	•	•	•
Patterned Aluminium Trim (C70 Collection with Toscana Tan Soft Leather)	•	•	•
Carbon Fibre Trim (C70 Collection with Off Black Soft Leather Upholstery)	•	•	•
Leather-faced Upholstery	•	•	•
Soft Leather Upholstery (Toscana Tan or Off Black)	•	•	•
Luxury Floor Mats	•	•	•
SC-805 RDS Single Slot CD Stereo Radio Cassette, 4 x 60W Amplifier with Auto Sound Control	•	•	•
SC-901 RDS 3 x CD Radio Cassette, 4 x 100W Amplifier with	•	•	•
Dolby Pro Logic Surround Sound ^{TM(i)} and 9" Subwoofers Behind Rear Seat	•	•	•
EXTERIOR	C70	COLLECTION	C70 GT
16" Zeus Alloy Wheels – 225/50 ZR16 Tyres	•	•	•
17" Otrera Alloy Wheels – 225/45 ZR17 Tyres	•	•	•
17" Cratos Alloy Wheels – 225/45 ZR17 Tyres ^(iv)	•	•	•
Locking Wheels Nuts	•	•	•
Tempa Spare Wheel	•	•	•
Front Fog Lights	•	•	•
Headlamp Wash/Wipe	•	•	•
Comfort Chassis (2.0T/2.4T only)	•	•	•
Dynamic Chassis (T5 only)	•	•	•
Colour Co-ordinated Bumpers and Door Mirrors	•	•	•
Aluminium Sill Covers	•	•	•
Wind Deflector	•	•	•
Full Electric Soft Top (Black) with Glass Rear Screen	•	•	•



SAFETY & SECURITY	Basic £	VAT £	Rec Retail Price £	Rec Retail Price € ⁽ⁱ⁾	C70	COLLECTION	C70 GT
Delete Passenger Airbag	–	–	–	–	nco	nco	nco
Inclination Sensor	£106.38	£18.62	£125.00	€187.00	o	o	o
INTERIOR	Basic £	VAT £	Rec Retail Price £	Rec Retail Price € ⁽ⁱ⁾	C70	COLLECTION	C70 GT
Automatic Transmission	£936.17	£163.83	£1,100.00	€1,645.60	o	o	o
Information Centre	£272.34	£47.66	£320.00	€487.72	o	o	•
First Aid Kit	£21.28	£3.72	£25.00	€37.40	o	o	o
Electric Driver and Passenger Seats (with Memory)	£936.17	£163.83	£1,100.00	€1,645.60	o	o	o
Heated Front Seats	£127.66	£22.34	£150.00	€224.40	o	•	•
Leather Sports Steering Wheel (Dark Grey)	£85.11	£14.89	£100.00	€149.60	o	•	nco
Red Wood/Leather Steering Wheel	£85.11	£14.89	£100.00	€149.60	o	n/a	nco
Red Wood Inlays/Red Wood Gear Knob (Gear Knob Auto only)	–	–	–	–	nco	n/a	nco
Soft Leather Upholstery	£297.87	£52.13	£350.00	€523.60	o	•	o
SC-901 RDS 3 x CD Stereo Radio Cassette (including 4 x 100W Amplifier)	£468.09	£81.91	£550.00	€822.80	o	o	nco
SC-901 RDS 3 x CD Stereo Radio Cassette, 4 x 100W Amplifier with Dolby Pro Logic Surround Sound ^{TM(ii)} and 9" Subwoofers Behind Rear Seat	£978.72	£171.28	£1,150.00	€1,720.40	o	o	•
RTI Navigation System with UK Disc Map ⁽ⁱⁱⁱ⁾	£1,489.36	£260.64	£1,750.00	€2,618.00	o	o	o
EXTERIOR	Basic £	VAT £	Rec Retail Price £	Rec Retail Price € ⁽ⁱ⁾	C70	COLLECTION	C70 GT
Black Paint (Solid)	£212.77	£37.23	£250.00	€374.00	o	n/a	o
Metallic/Pearlescent Paint ^(v)	£425.53	£74.47	£500.00	€748.00	o	•	o
16" Zeus Alloy Wheels – 225/50 ZR16 Tyres	–	–	–	–	•	n/a	nco
17" Comet Alloy Wheels – 225/45 ZR17 Tyres	£255.32	£44.68	£300.00	€448.80	o	nco	nco
17" Cratos Alloy Wheels – 225/45 ZR17 Tyres	£255.32	£44.68	£300.00	€448.80	o	nco	•
17" Propus Alloy Wheels – 225/45 ZR17 Tyres	£425.53	£74.47	£500.00	€748.00	o	u (£200)	u (£200)
Dynamic Chassis (Standard Height) (2.0T, 2.4T only)	£85.11	£14.89	£100.00	€149.60	o	o	o
Lowered Dynamic Chassis – (nco – T5)	£170.21	£29.79	£200.00	€299.20	o	o	o
Full Electric Soft Top (Blue) with Glass Rear Screen	–	–	–	–	nco	n/a	nco



16" Zeus



17" Cratos



17" Propus

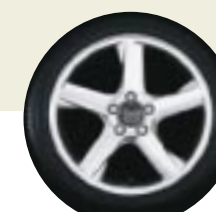

17" Comet



17" Otrera

CONVENIENCE PACK	Basic £	VAT £	Rec Retail Price £	Rec Retail Price € ⁽ⁱ⁾	C70	COLLECTION	C70 GT
SC-901 RDS 3 x CD Radio Cassette, 4 x 100W Amplifier with Dolby Pro Logic Surround Sound ^{TM(iii)} , 9" Subwoofers Behind Rear Seat, Autodimming Rear View Mirror, Front Cupholders and Information Centre	£765.95	£134.05	£900.00	€1,346.40	n/a	o	•

• = standard, o = optional, nco = no cost option, u(£) = upgrade.

(i) Euro prices shown are for information only and are calculated using an exchange rate of 1.496 Euros to the £, as published in the Financial Times on 31st March 2004.

Euro prices will be subject to the prevailing exchange rate at the time of purchase. These figures are for information purposes only.

(ii) Dolby and Pro Logic Surround SoundTM are trademarks of Dolby Laboratories Licensing Corporation.

(iii) Cannot be ordered in conjunction with Dolby Pro Logic Surround Sound^{TM(iii)} – must be ordered with SC-901 RDS 3 x CD Stereo Radio Cassette.

(iv) The nco 16" alloy wheels will provide a more comfortable ride than the standard 17" alloy wheels.

(v) Volvo C70 Collection is available in Black Sapphire Metallic, Titanium Grey Pearl or Silver Metallic paint only.



ACCESSORIES	Basic £	VAT £	Rec Retail Price £	Rec Retail Price € ⁽ⁱ⁾
EXTERIOR ACCESSORIES (PRICES EXCLUDE FITTING UNLESS SHOWN OTHERWISE).				
Park Assist, Rear ⁽ⁱⁱ⁾	£316.03	£55.31	£411.32	€615.33
Sports Exhaust System ⁽ⁱⁱ⁾	£425.53	£74.47	£500.00	€748.00
Load Carrier (boot lid)	£204.26	£35.74	£240.00	€359.04
Load Carrier Brake Lamp	£24.68	£4.32	£29.00	€43.38
Mobile phone kits	Available Q4 2004.			

- (i) Euro prices shown are for information only and are calculated using an exchange rate of 1.496 Euros to the £, as published in the Financial Times on 31st March 2004. Euro prices will be subject to the prevailing exchange rate at the time of purchase. These figures are for information purposes only.
- (ii) Accessory only. Indicates total fitted price post registration. At participating dealers only. To find out who is a participating dealer contact the Volvo Helpline number on 0800 400 430.

For further information and a complete list of all Volvo Accessories, just take a look at the new Accessory website at www.volvocars.co.uk/accessories

UPHOLSTERY

LEATHER



Light Beige (1966)



Granite (1944)



Grey (1970)

SOFT LEATHER



Linen White (17B6)



Grey (1770)

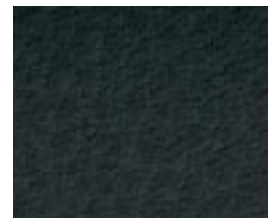

Off Black (1771)



Toscana Tan (17J0)

INTERIOR INLAYS



Red Wood



Patterned Aluminium

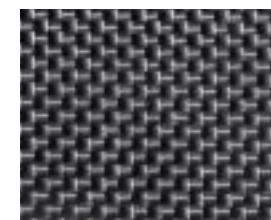

Carbon Fibre

HOOD COLOUR

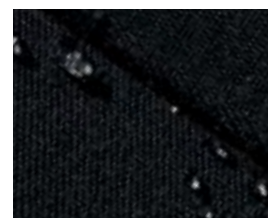

Black (standard)



Navy Blue

ENGINE	2.0T	2.4T	T5
Configuration	Transverse – 20 valve	Transverse – 20 valve	Transverse – 20 valve
Cylinders	5	5	5
Engine capacity, cc	1984	2435	2319
Bore x Stroke, mm	81 x 77	83 x 90	81 x 90
Max. output ECE, bhp/kw/rpm	163/120/5100	200/147/5700	245/180/5400
Max. torque ECE, Nm/rpm	230/1800-5000	285/1800-5000	330/2400-5100
Octane rating	95-98 ⁽ⁱ⁾ RON unleaded	95-98 ⁽ⁱ⁾ RON unleaded	95-98 ⁽ⁱ⁾ RON unleaded
Fuel system	Multipoint Fuel Injection	Multipoint Fuel Injection	Multipoint Fuel Injection
Compression ratio	9.5:1	9.0:1	8.5:1

INSURANCE GROUPS	2.0T/2.0T GT	2.4T GT	T5 GT
Volvo C70 Convertible	15/16	17	18

WEIGHTS	All models
Min. kerb weight, kg (actual kerb weight dependent on spec.)	1565
Max. possible towing weight braked, kg	1600
Max. towing weight unbraked approx, kg ^(iv)	500
Max. total weight, kg	2020
Max. roof load, kg	N/A
Max. payload, kg (dependent on spec.)	455

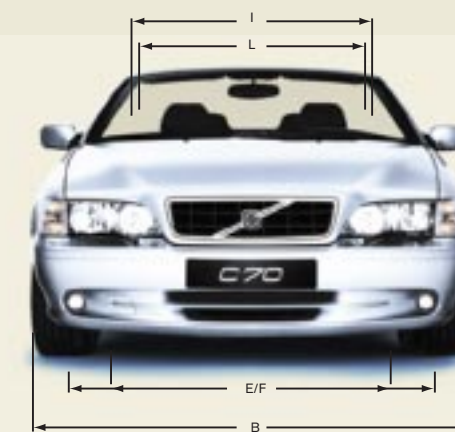
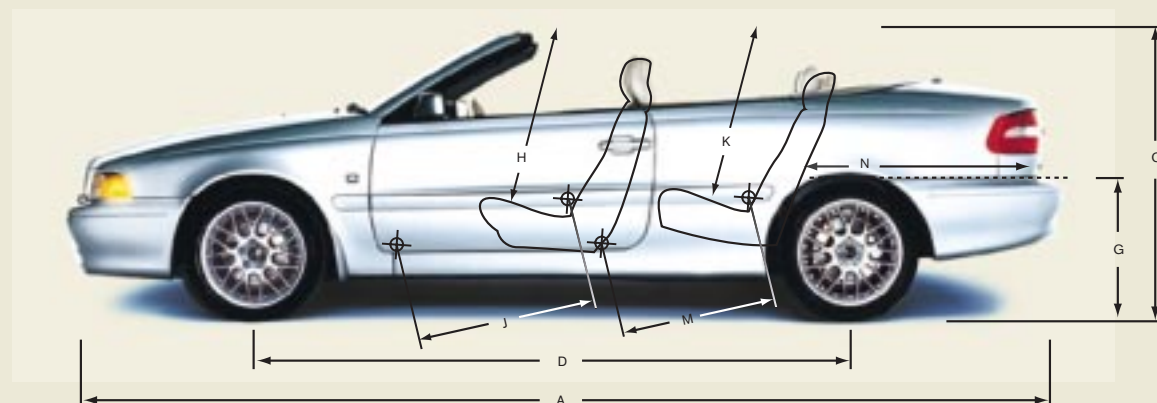

EXTERIOR (mm)		INTERIOR (mm)	
A Overall length	4716	H Front seat max. headroom	995
B Overall width (exc. wing mirrors)	1817	I Front seats width	1410
C Unladen height	1429	J Front seat max. legroom	1051
D Wheelbase length	2664	K Rear seat max. headroom	986
E Front track width	1521	L Rear seats width	1140
F Rear track width	1518	M Rear seat max. legroom	879
G Ground to boot base height	706	N Load length luggage 4 seat mode	820

PERFORMANCE	2.0T Man	2.0T Auto	2.4T Man	2.4T Auto	T5 Man	T5 Auto
Top speed, mph	130	124	137	130	149	143
Acceleration 0-62mph, sec	9.9	10.7	8.5	9.0	7.5	8.0

TRANSMISSION	All models
Manual	5
Automatic	5

POWER STEERING SYSTEM	All models
(rack & pinion) Turning circle, m (ft)	11.7 (38'4")

FUEL CONSUMPTION ⁽ⁱⁱⁱ⁾	2.0T Man	2.0T Auto	2.4T Man	2.4T Auto	T5 Man	T5 Auto
(Government Approved) Mpg (l/100km) ⁽ⁱⁱ⁾ Urban	20.9 (13.5)	18.1 (15.6)	20.6 (13.7)	17.7 (16.0)	20.6 (13.7)	17.7 (16.0)
Extra Urban	38.2 (7.4)	36.7 (7.7)	36.7 (7.7)	35.3 (8.0)	36.7 (7.7)	35.3 (8.0)
Combined	29.1 (9.7)	26.6 (10.6)	28.5 (9.9)	25.9 (10.9)	28.5 (9.9)	25.9 (10.9)
CO ₂ g/km	230	253	236	261	236	261
VED (Vehicle Excise Duty) Band	D	D	D	D	D	D

BRAKES	All models
Disc diameter mm, front	302 Ventilated
Disc diameter mm, rear	295

LUGGAGE COMPARTMENT	All models
Volume, litres (cu.ft)	223 (8.1)

PERFORMANCE	All models
Drag co-efficient	0.34

FUEL TANK	All models
Volume, litres (gallons)	68 (15.0)

- (i) For best performance and lowest fuel consumption 98 RON is recommended. 95 RON can be used for normal driving.
- (ii) The Urban fuel consumption figure is based on typical city driving, including starting the car from cold. The Extra Urban figure is based on typical motorway driving and cruising. The Combined figure averages the consumption across both cycles.
- (iii) These results do not express or imply any guarantee of the fuel consumption of a particular car as there are inevitable differences between individual cars of the same model. Additionally driving style, traffic conditions, as well as the age and mileage and standard of maintenance will affect a car's fuel consumption.
- (iv) Unbraked towing weight must not exceed 50% of kerb weight up to a maximum of 750 kg.

Notes
Some specifications may have lower CO₂ emissions than those shown. Once a vehicle has been built it will be given its own specific CO₂ emission figure on which Vehicle Excise Duty and company car tax, where appropriate, will be calculated. Please contact your dealer for details.
A weighbridge must be used to determine specific weights.
Data valid for manual transmission unless specified.
All measurements in mm.
NB Some of the information in this price list may not be correct due to product changes which may have occurred since it was printed. Some of the equipment described or shown may now be available only at extra cost. Before ordering, please ask your Volvo dealer for the latest information. The manufacturer reserves the right to make changes at any time, without notice, to prices, colour, materials, specifications and models.
Volvo Car UK Limited, Globe Park, Marlow, Buckinghamshire, SL7 1YQ

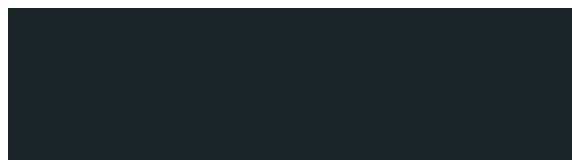

019 Black Stone

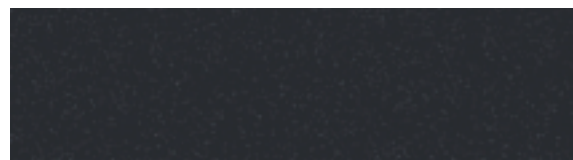

452 Black Sapphire metallic



417 Nautic Blue pearl



455 Titanium Grey pearl

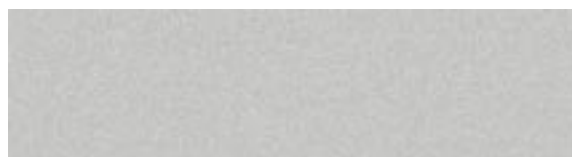

426 Silver metallic



461 Sky Blue pearl



443 Moondust metallic



612 Passion Red



CARE
BY VOLVO

IT'S SIMPLICITY ITSELF. ONE POINT OF CONTACT FOR ALL YOUR CAR OWNERSHIP NEEDS. WHETHER IT'S ABOUT FINDING THE RIGHT FINANCE DEAL OR WHO TO CONTACT IN AN EMERGENCY. TRUST CARE BY VOLVO TO ENJOY A VERY SPECIAL CAR OWNERSHIP.

STARTING OFF ON THE RIGHT FOOT
You'll be surprised how easy and flexible financing can be. Our range of finance, service and insurance options allow you to budget around one key factor - your lifestyle.

MAKING LIFE EASIER
Owning a Volvo is all about discovering the safest, most exciting, driving experience. To ensure it always stays that way, we're committed to providing you with the best in aftersales support.

LOOKING AHEAD
You'll probably never find out just how good some of our services are, but should the unexpected happen you'll discover yet more reasons why buying a Volvo was the right choice.

FINANCE/LEASE

As part of Volvo, Volvo Car Finance has developed a series of finance plans that will provide you with maximum choice and flexibility when acquiring a Volvo.

SERVICE PROGRAMME

Your Volvo dealer has the unique know-how to tailor a service programme according to Volvo's strict recommendations and guarantees you years of safety and driving pleasure.

ROADSIDE ASSISTANCE

Every new car comes with one year's free RAC cover. You'll enjoy full breakdown and recovery assistance, anywhere in Europe, 24 hours a day. You can even extend cover for up to two more years at preferential rates.

INSURANCE

Statistics show Volvo drivers have fewer accidents. That means Volvo Owners Insurance can offer competitive premiums with tailored protection and exclusive benefits. Operated in partnership with The Royal & SunAlliance, one telephone call even deals with all arrangements for any claim. Call direct on 0800 238 239 to obtain a free no obligation quote⁽ⁱ⁾.

WARRANTY

Every new Volvo comes with comprehensive protection. Our warranty covers the first three years or 60,000 miles, whichever comes first. There's a three year unlimited warranty on the paintwork, and a full eight years against rust perforation. If a component fails due to a defect or material fault, your dealer will swiftly rectify the problem, free of charge.

All 'On The Road' prices quoted in this price list include Volvo standard national delivery charge, inclusive of number plates, at £480 and the VED (Vehicle Excise Duty) car tax effective from 1st March 2000. The 'On The Road' price also includes a £38 vehicle first registration fee (as set by the government), effective since 1st April 1998 (excludes Channel Islands and Isle of Man). Retail prices quoted do not include these additions.

For tax free sales, including Military, Diplomat and all other Export enquiries, contact Volvo Car UK Ltd (Military, Diplomat and International Customer Sales) on 01707 262388, e-mail to vcuktds@volvocars.com or bms@volvocars.com

WHAT NEXT? If you'd like to find out more about the range of products and services that make up Care by Volvo, the story continues at www.volvocars.co.uk

Alternatively you can contact your nearest Volvo dealer or request relevant brochures.

(i) Volvo Owners Insurance is underwritten by Royal & Sun Alliance Insurance plc No. 93792. Registered in England and Wales at St Mark's Court, Chart Way, Horsham, West Sussex RH12 1XL. Member of the General Insurance Standards Council. For your protection telephone calls will be recorded and may be monitored.

VOLVO

Volvo Car UK Limit
www.volvocars.co.uk